

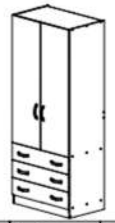

BETTY 02 BE02-001-00



V PŘÍPADĚ REKLAMACE JE POTŘEBA NAHLÁSIT VÝROBNÍ ČÍSLO VIDITELNÉ NA ETIKETU







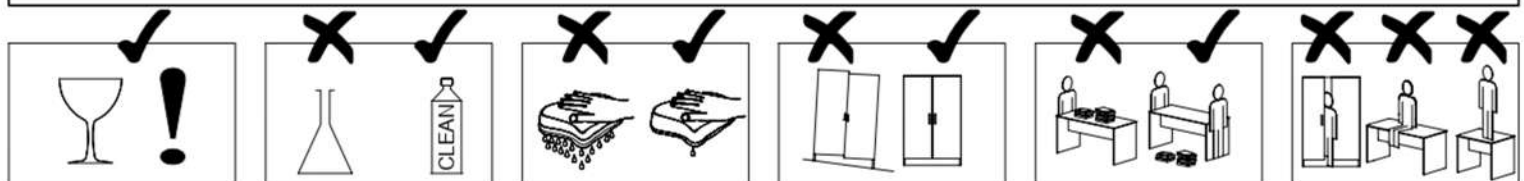

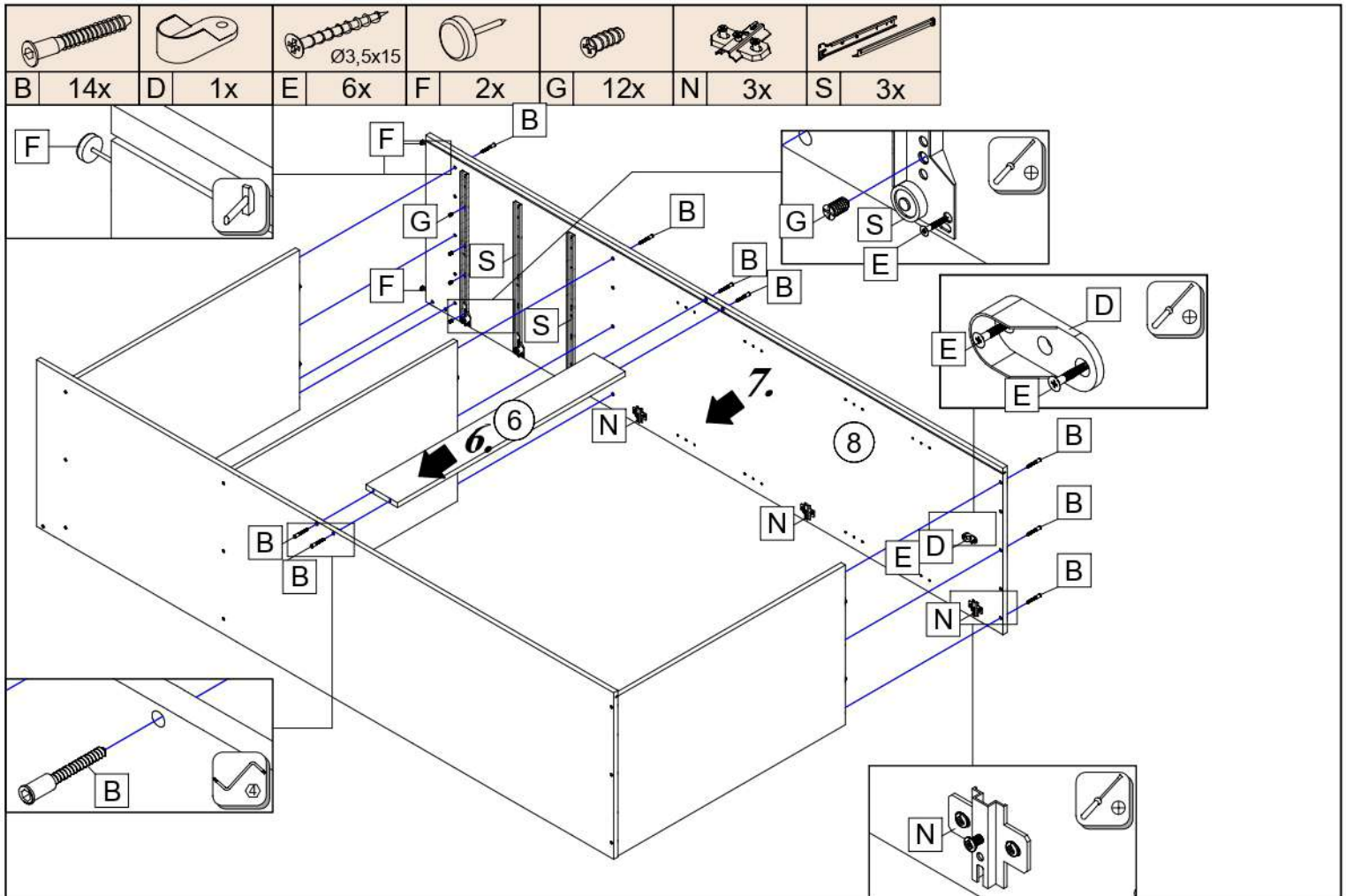
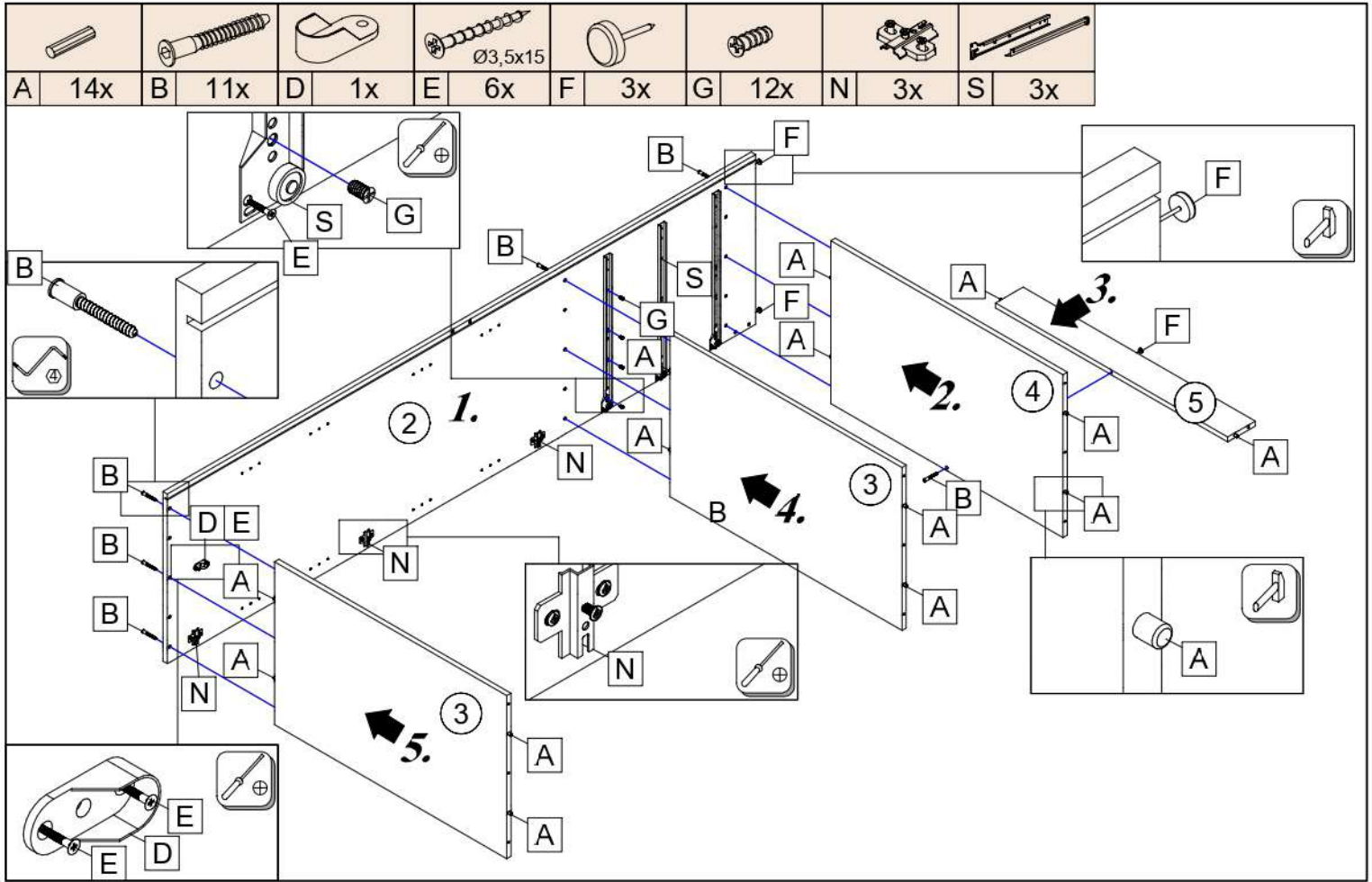
27000,00	22300,00			22243,00	30091,00	22705,00	70013,01	70021,01	
A 20x	B 37x	C 24x	D 2x	E 42x	F 5x	G 24x	H 12	J 12x	L 46x
M 8x	N 6x	P 6x	Q 1x	S 3x					
1h 20min		4	PZ 2	≤ 0,5 kg	0,6m	3m			

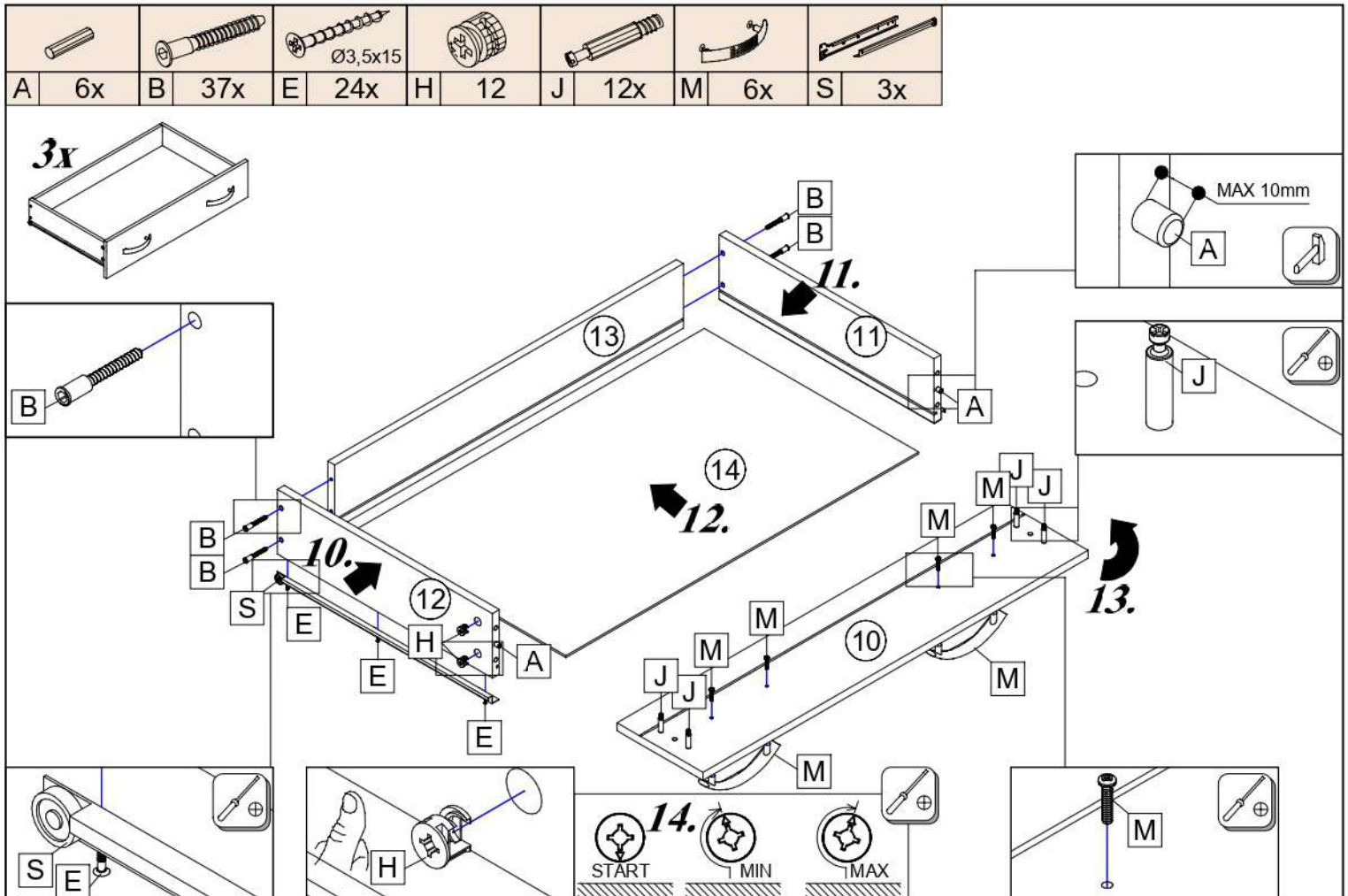
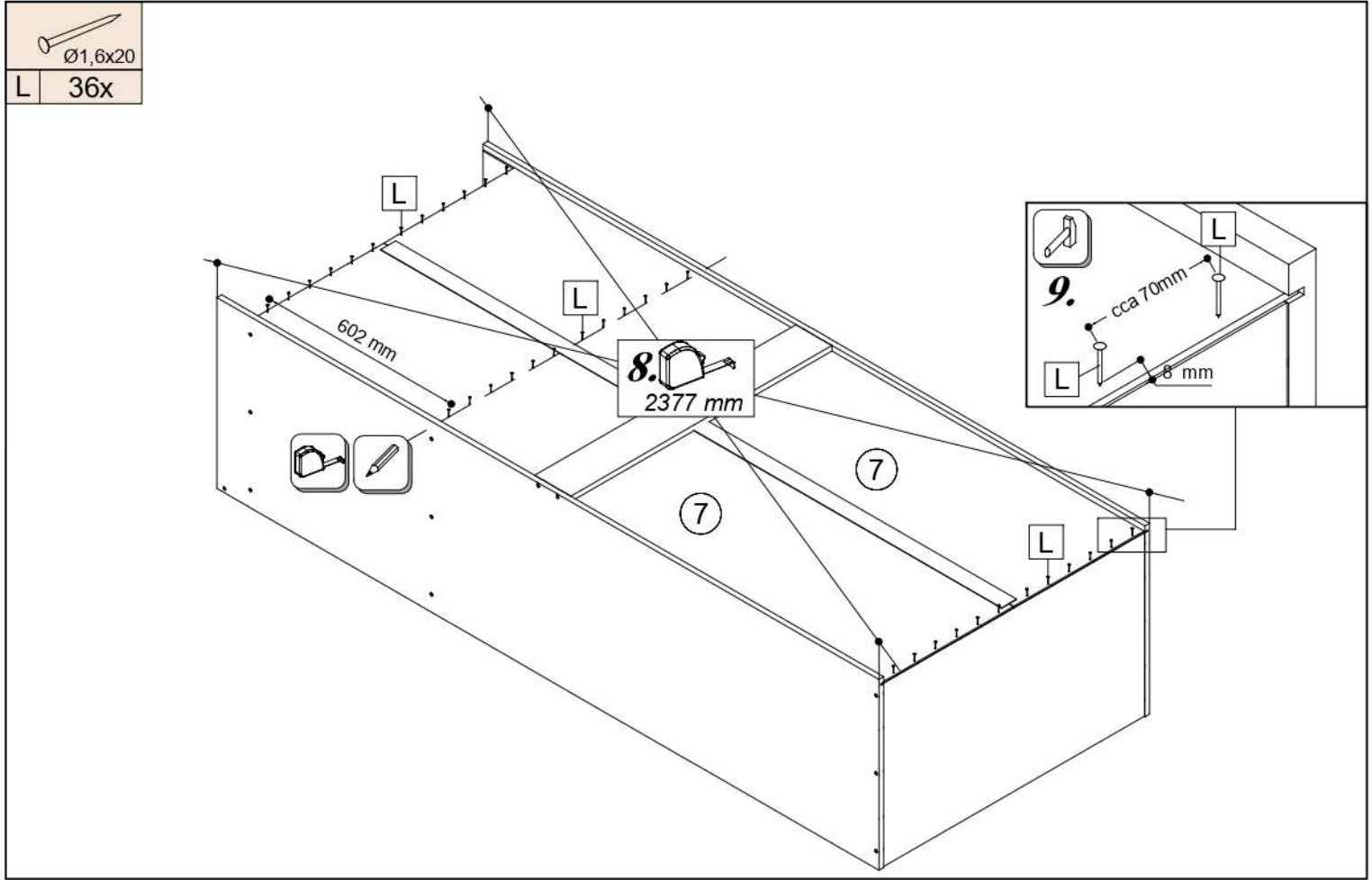
ID	ID	Image	Quantity	Ratio
01315	2		1x	3/3
01316	3		2x	1/3
01317	4		1x	1/3
01318	5		1x	1/3
01319	6		1x	2/3
01320	7		2x	3/3
01321	8		1x	3/3
01322	9		1x	2/3
01324	10		3x	2/3
01325	11		3x	2/3
01326	12		3x	2/3
01327	13		3x	1/3
01328	14		3x	1/3
01323	15		1x	2/3







				
C 24x	E 12x	M 2x	P 6x	Q 1x

